

DEVELOPMENT OF AN AC-DC BUCK POWER FACTOR CORRECTION

MUHAMMAD ISKANDAR BIN IBRAHIM

A PROJECT REPORT SUBMITTED IS PARTIAL FULFILMENT THE  
REQUIREMENT FOR THE AWARD OF MASTER OF ELECTRICAL ENGINEER



PTTA UTHM  
PERPUSTAKAAN TUNKU TUN AMINAH  
FACULTY OF ELECTRICAL AND ELECTRONICS ENGINEERING  
UNIVERSITI TUN HUSSIEN ONN MALAYSIA

FEB 2013

## ABSTRACT

Generally all device used in industrial, commercial and residential applications need to undergo rectification for their proper functioning and operation. It connected to the non-linear loads which results in production of non-sinusoidal line current. Due to the increasing demand of these devices, the line current non-sinusoidal pose a major problem by degrading the power factor of the system thus affecting the performance of the devices. Hence there is a need to reduce the line current non-sinusoidal so as to improve the power factor of the system and led to designing of Power Factor Correction circuits. Power Factor Correction (PFC) involves two techniques, Active PFC and Passive PFC. In our project work we have designed an active power factor circuit using Buck Converter for improving the power factor. The advantage of using Buck Converter in power factor correction circuits is that better line regulation is obtained with appreciable power factor. Simulation and experimental are conducted to validate the theoretical analysis. The results show that the power factor can be improved.



PTAAUTHM  
PERPUSTAKAAN TUNJUKKAN AMINAH

## TABLE OF CONTENTS

CHAPTER	ITEM	PAGE
	Title	I
	Declaration	II
	Acknowledgment	III
	Abstract	IV
	Table of Contents	V
	List of Figure	VII
<b>CHAPTER 1</b>	<b>INTRODUCTION</b>	<b>1</b>
1.1	Project Background	1
1.2	Problem Statements	3
1.3	Project Objectives	3
1.4	Project Scopes	3
<b>CHAPTER 2</b>	<b>LITERATURE REVIEW</b>	<b>4</b>
2.1	Theories	4
2.2	Description of Previous Methods	4
2.3	Introduction to Buck converter	6
2.3.1	Circuit description	6
2.3.2	Circuit Operation	6
2.4	Introduction of PID controller	8



PTTA UTHM  
PERPUSTAKAAN TUNKU TUN AMINAH

<b>CHAPTER 3</b>	<b>METHODOLOGY</b>	9
3.1	Introduction	9
3.1.1	Identify Design Requirement	10
3.1.1.1	Theory of Power Factor	10
3.1.1.2	Theory of Rectifier	11
3.2	PID control design	12
3.2.1	Derivative Term	13
3.2.2	Integral Term	14
3.2.3	Proportional Term	15
3.3.	Saw-Tooth Signal Generator	16
3.4	Buck converter formula	17
<b>CHAPTER 4</b>	<b>SIMULATION MODEL</b>	18
4.1	Simulation Close Loop Result	18
4.1.1	Changes of Output Load	23
4.1.2	Hardware Close loop Result	32
4.1.3	Sawtooth Waveform	32
4.1.4	IGBT Waveform	33
4.1.5	Analysis of PID controller	34
4.2	Simulation Open Loop Result	36
4.2.1	Changes of Output Load	39
4.2.2	Hardware Open loop Result	44
4.2.3	Analysis of Input current	45
<b>CHAPTER 5</b>	<b>Conclusion and discussion</b>	48
5.1	Conclusion	48
5.2	Recommendation	48
	<b>REFERENCES</b>	50



## LIST OF FIGURE

No.	Title	Page
Figure 1	Input voltage from full-bridge rectifier and typical drive that can drive Buck-Boost	4
Figure 2	Buck, Boost and Buck-Boost basic system and waveform	5
Figure 3	Buck converter during switch ON and OFF	7
Figure 4	Project Plan	9
Figure 5	Ratio between P(Real), Q(Reactive) and S(Apparent)	10
Figure 6	Voltage, Current and Power Factor	11
Figure 7	Simple rectifier without power factor correction (PFC) draws current from the AC mains with a high harmonic content, and hence a low power factor	12
Figure 8	Plot of PV vs time, for three values of $K_d$ ( $K_p$ and $K_i$ held constant)	13
Figure 9	Plot of PV vs time, for three values of $K_i$ ( $K_p$ and $K_d$ held constant)	14
Figure 10	Plot of PV vs time, for three values of $K_p$ ( $K_i$ and $K_d$ held constant)	15
Figure 11	Saw-tooth waveform generator	16
Figure 12	AC-DC by using Step-down transformer and rectifier	18
Figure 13	AC-DC by using rectifier and Buck PFC circuit	18
Figure 14	Rectifier input current and voltage of AC-DC by using Step-down transformer and rectifier	19
Figure 15	Buck input current and voltage of AC-DC by using rectifier and Buck PFC circuit	19
Figure 16	Rectifier, Active and Reactive Power of AC-DC by using Step-down transformer and rectifier	20
Figure 17	Buck Active and Reactive Power of AC-DC by using rectifier and Buck PFC circuit	20
Figure 18	Rectifier THD and power factor of AC-DC by using Step-down transformer and rectifier	21
Figure 19	Buck THD and power factor of AC-DC by using rectifier and Buck PFC circuit	21
Figure 20	Rectifier Output Voltage of AC-DC by using Step-down transformer and rectifier	22



PTIA UTHM  
PERPUSTAKAAN TUNKU AMINAH

Figure 21	Buck Output Voltage of AC-DC by using rectifier and Buck PFC circuit	22
Figure 22	Output load 10,000ohm for Output Voltage of AC-DC by using rectifier and Buck PFC circuit	23
Figure 23	Output load 1,000ohm for Output Voltage of AC-DC by using rectifier and Buck PFC circuit	23
Figure 24	Output load 100ohm for Output Voltage of AC-DC by using rectifier and Buck PFC circuit	24
Figure 25	Output load 10ohm for Output Voltage of AC-DC by using rectifier and Buck PFC circuit	24
Figure 26	Output load 10,000ohm for Power Factor of AC-DC by using rectifier and Buck PFC circuit	25
Figure 27	Output load 1,000ohm for Power Factor of AC-DC by using rectifier and Buck PFC circuit	25
Figure 28	Output load 100ohm for Output Factor of AC-DC by using rectifier and Buck PFC circuit	26
Figure 29	Output load 10ohm for Power Factor of AC-DC by using rectifier and Buck PFC circuit	26
Figure 30	Output load 10,000ohm for Input Current & Voltage of AC-DC by using rectifier and Buck PFC circuit	27
Figure 31	Output load 1,000ohm for Input Current & Voltage of AC-DC by using rectifier and Buck PFC circuit	27
Figure 32	Output load 100ohm for Input Current & Voltage of AC-DC by using rectifier and Buck PFC circuit	28
Figure 33	Output load 10ohm for Input Current & Voltage of AC-DC by using rectifier and Buck PFC circuit	28
Figure 34	Output load 10ohm, 0.1H for Output Voltage of AC-DC by using rectifier and Buck PFC circuit	29
Figure 35	Output load 10ohm, 1H for Output Voltage of AC-DC by using rectifier and Buck PFC circuit	29
Figure 36	Output load 10ohm, 0.1H for Input Current & Voltage of AC-DC by using rectifier and Buck PFC circuit	30
Figure 37	Output load 10ohm, 1H for Input Current & Voltage of AC-DC	30



	by using rectifier and Buck PFC circuit	
Figure 38	Output load 10ohm, 0.1H for Power Factor of AC-DC by using rectifier and Buck PFC circuit	31
Figure 39	Output load 10ohm, 1H for Input Current & Voltage of AC-DC by using rectifier and Buck PFC circuit	31
Figure 40	With Buck Converter	32
Figure 41	Without Buck-Converter	32
Figure 42	Hardware waveform for sawtooth & PWM	33
Figure 43	Hardware waveform for IGBT-Gate current & PWM	34
Figure 44	AC-DC Using Rectifier by Close Loop Feedback	35
Figure 45	Hardware waveform for Input Current & Voltage	35
Figure 46	Simulation model for Buck PFC open loop	36
Figure 47	Power factor simulation result for Buck PFC open loop	37
Figure 48	Active and reactive simulation result for Buck PFC open loop	38
Figure 49	Output load 1ohm for Output Voltage of AC-DC by using rectifier and Buck PFC circuit (Open Loop)	39
Figure 50	Output load 10ohm, 10H for Output Voltage of AC-DC by using rectifier and Buck PFC circuit (Open Loop)	40
Figure 51	Output load 100ohm for Output Voltage of AC-DC by using rectifier and Buck PFC circuit (Open Loop)	40
Figure 52	Output load 1ohm for Input Voltage & Current of AC-DC by using rectifier and Buck PFC circuit (Open Loop)	41
Figure 53	Output load 10ohm, 10H for Input Voltage & Current of AC-DC by using rectifier and Buck PFC circuit (Open Loop)	42
Figure 54	Output load 100ohm for Input Voltage & Current of AC-DC by using rectifier and Buck PFC circuit (Open Loop)	42
Figure 55	Output load 1ohm for Power Factor of AC-DC by using rectifier and Buck PFC circuit (Open Loop)	43
Figure 56	Output load 10ohm, 10H for Power Factor of AC-DC by using rectifier and Buck PFC circuit (Open Loop)	43
Figure 57	Output load 100ohm for Power Factor of AC-DC by using rectifier and Buck PFC circuit (Open Loop)	43
Figure 58	AC-DC Using Rectifier by Open Loop Feedback	44



PTTA UTHM  
PERPUSTAKAAN TUNKUN AMINAH

Figure 59	Simulation vs Hardware for input current & voltage	45
Figure 60	Hardware Power Factor result for Buck PFC open loop	46
Figure 61	Hardware output voltage result for Buck PFC open loop	47



PTTA UTHM  
PERPUSTAKAAN TUNKU TUN AMINAH



## CHAPTER 1

### INTRODUCTION

#### 1.1 Project Background

Power factor can be defined as:-

The ratio of active or real power to the apparent power.

$$\begin{aligned}
 P.F &= \frac{\text{Real Power}}{\text{Apparent Power}} \\
 &= \frac{P}{V_{rms} \times I_{rms}} \\
 &= \frac{\text{Watts}}{V.A}
 \end{aligned}$$

If the load is purely resistive, then the real power will be same as  $V_{rms} \times I_{rms}$  factor will be 1.0. And if the load is not purely resistive, the power factor will be below 1.0. Hence, the PFC are developed especially for non-linear load so that the power factor is improved which means it tries to make the input current in response to the input voltage, so that a constant ratio is maintained between the voltage and current. This would ensure the input to be resistive in nature and thus, the power factor to be 1.0 or unity.

Nearly all single-phase AC-to-DC power supplies have a full-wave bridge rectifier circuit on the input, which attempts to hold its DC voltage constant between the half-cycle peaks of the input voltage sine wave. The capacitor charging current only flows when the input voltage (less the voltage drops across the rectifiers) is greater than the voltage on the capacitor; when it is less, the rectifiers are off and little or no current flows. Therefore, the current is highly non-sinusoidal. Uncorrected power factors may be as low as 0.5 or 0.6 for this type of rectifier design. Hence, various measures are taken to improve the power factor of a system.

Some study describes the use and design of a Buck Converter and Boost pre-regulator for the Power Factor Correction[1], [2]. Then compares various DC-DC Converter topologies for Power Factor Correction [3].

Power Factor Correction circuit is to make the line current follow the waveform of the line voltage. It will make the load behaves like a purely resistor and hence to improve the power factor. Our project work makes the use of Buck Converter in the Power Factor Correction circuit so as to improve the power factor.

We started our project by study and analysis of power factor of a system. Then make simulations on MATLAB simulation software using full wave rectifier. After studying and analyzing the input current and voltage waveforms, we introduced a Buck Converter in the circuit and then analyzed its effect in improving the power factor of the system.

## 1.2 Problem Statements

Power factor in non-linear load such as rectifier distort the current from the system. Power factor can be increase by passive or active power factor. This system can change waveform drawn by load to linear load. The purpose of this project is to improve power factor on AC to DC rectifier circuit.

## 1.3 Project Objectives

This project has been developed to enhance the achievement in the following matter:-

- a) To implement simulation of PFC of Buck Converter using software MATLAB simulink.
- b) To construct hardware of PFC of Buck Converter.

## 1.4 Project Scopes

The scope of this project is segregate with software development and hardware development:

- a) Simulation converter using MATLAB simulink software
- b) Testing the converter to compute the result same as simulation and can achieve the output.

## CHAPTER 2

### LITERATURE REVIEW

#### 2.1 Theories

In this chapter, three of the most common topologies of PFC implement. Advantages and disadvantages for each of them will highlight. The common topologies are buck, boost and buck boost.

#### 2.2 Description of Previous Methods

Starting with the Buck converter, the output voltage provided to the load is always less than the input terminal which also know as step-down converter. For the implementation of PFC, buck converter will function in discontinue condition due to AC signal.

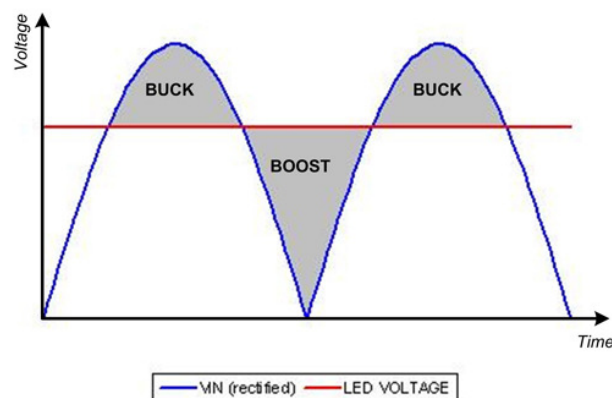

Figure 1: Input voltage from full-bridge rectifier and typical drive that can drive Buck-Boost

The Boost converter has the output voltage greater than the input which is known as a step-up converter. When using this topology, the PFC the current is continuous. As shown in the current diagram, CCM (Continuous Conduction Mode) allows a continuous current through the inductor.

The combination of the Buck Boost converter, as the name suggests, is a combination of a buck converter and a boost converter, so that the characteristics of both are achievable. The output voltage can be greater or lower than the input voltage.

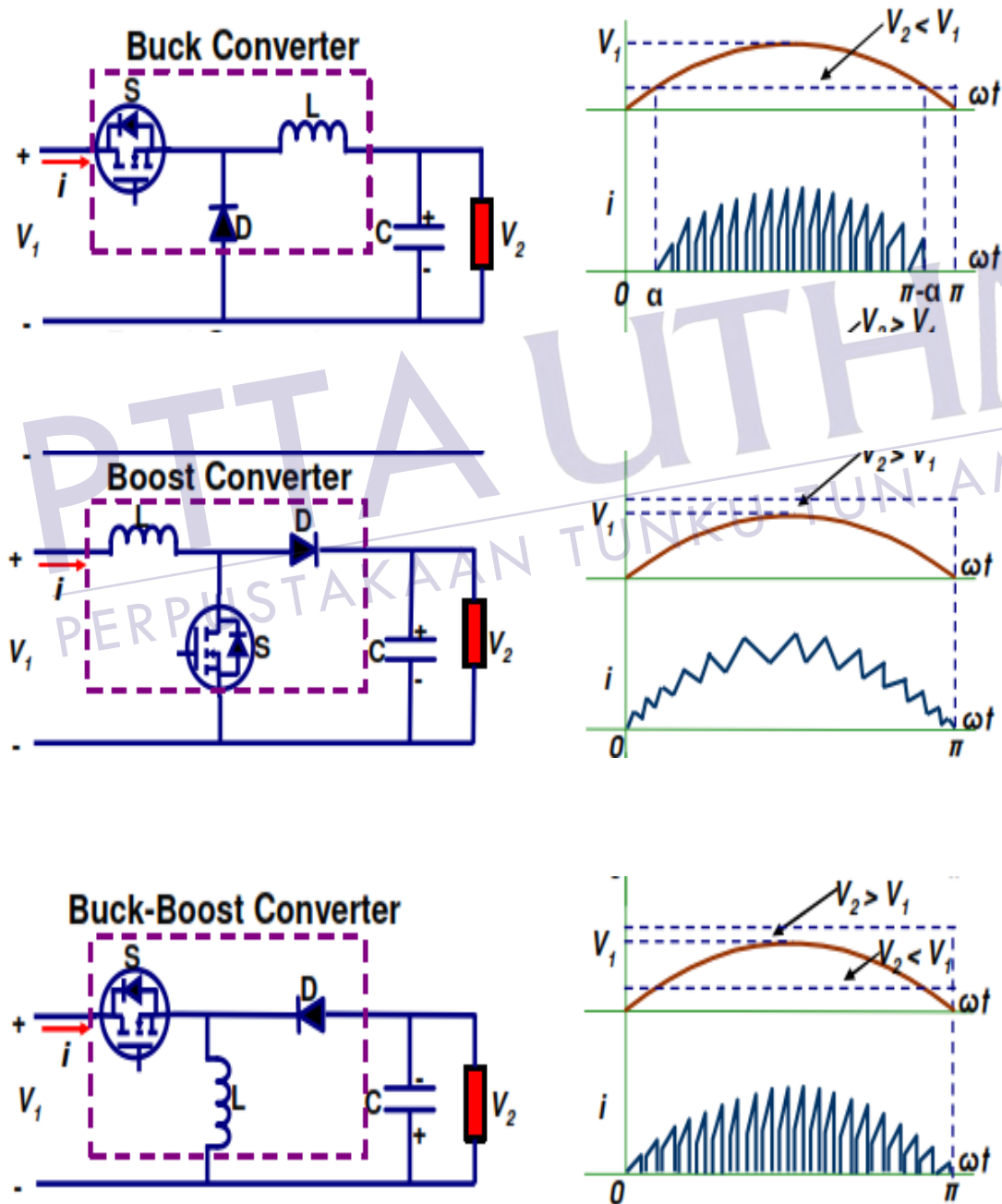

Figure 2: Buck, Boost and Buck-Boost basic system and waveform

One disadvantage of the buck and buck-boost topology is that the switch is not refer to ground, which makes the driver circuitry complex. The buck-boost topology also inverts the sign of the output voltage, which bring another disadvantage when comes to a cost.

### 2.3: Introduction to Buck converter

**2.3.1 Circuit description.** The three basic dc-dc converters use a pair of switches, usually one controlled (MOSFET) and one uncontrolled (diode), to achieve unidirectional power flow from input to output. The converters also use one capacitor and one inductor to store and transfer energy from input to output. They also filter or smooth voltage and current.

The dc-dc converters can have two distinct modes of operation: Continuous conduction mode (CCM) and discontinuous conduction mode (DCM). In practice, a converter may operate in both modes, which have significantly different characteristics. Therefore, a converter and its control should be designed based on both modes of operation. However, for this course we only consider the dc-dc converters operated in CCM.

**2.3.2 Circuit Operation.** When the switch is on for a time duration  $DT$ , the switch conducts the inductor current and the diode becomes reverse biased. This results in a positive voltage  $v = V_g - V_o$  across the inductor. This voltage causes a linear increase in the inductor current  $i$ . When the switch is turned off, because of the inductive energy storage,  $i$  continue to flow.

This current now flows through the diode, and  $v_L = -V_oL$  for a time duration  $(1-D)T$  until the switch is turned on again.

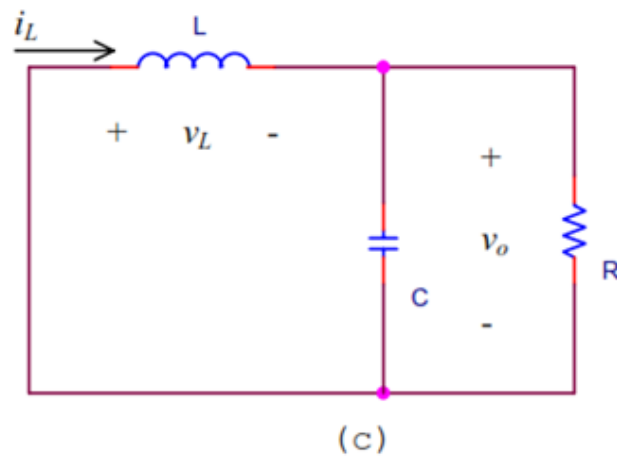
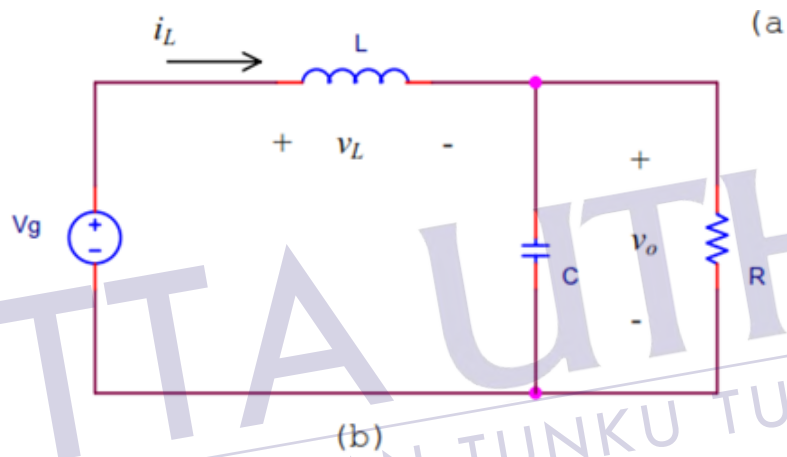
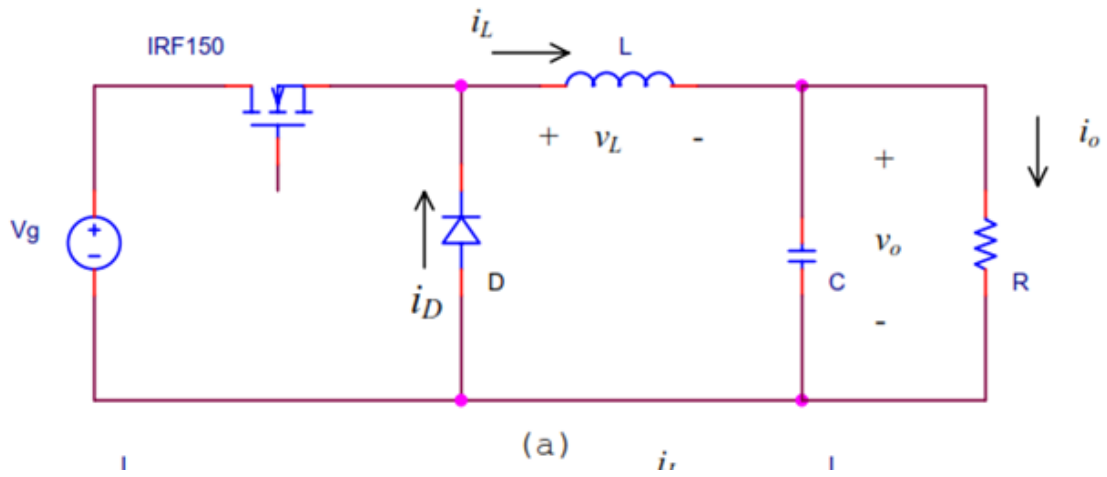

Figure 3: Buck converter during switch ON and OFF

### 2.3 Introduction of PID controller

The PID controller is the most common form of feedback. It was an essential element of early governors and it became the standard tool when process control emerged in the 1940s. In process control today, more than 95% of the control loops are of PID type, most loops are actually PI control. PID controllers are today found in all areas where control is used. The controllers come in many different forms. There are stand-alone systems in boxes for one or a few loops, which are manufactured by the hundred thousands yearly. PID control is an important ingredient of a distributed control system. The controllers are also embedded in many special-purpose control systems. PID control is often combined with logic, sequential functions, selectors, and simple function blocks to build the complicated automation systems used for energy production, transportation, and manufacturing. Many sophisticated control strategies, such as model predictive control, are also organized hierarchically. PID control is used at the lowest level; the multivariable controller gives the set points to the controllers at the lower level. It is an important component in every control engineer's tool box.





## CHAPTER 3

### METHODOLOGY

#### 3.1 Introduction

The focus of this chapter is to provide further details of methodology and approaches to completing this research. This chapter discusses on three main parts, which is PID controller, Sawtooth generator and Buck-converter.

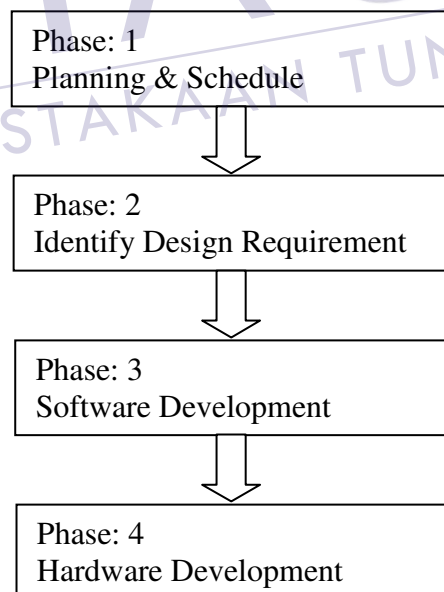

Figure 4: Project Plan

### 3.1.1 Identify Design Requirement

#### 3.1.1.1 Theory of Power Factor

The Power Factor is defined as the ratio between the Real Power and the Apparent Power in an AC circuit. The Real Power represents the net transferred energy transferred to the load over one complete AC cycle while the Reactive Power represents the fraction that is only temporarily stored by the load. The Real Power is the one measured and monitored for power consumption, and its associated energy being is used to produce mechanical work and heating.

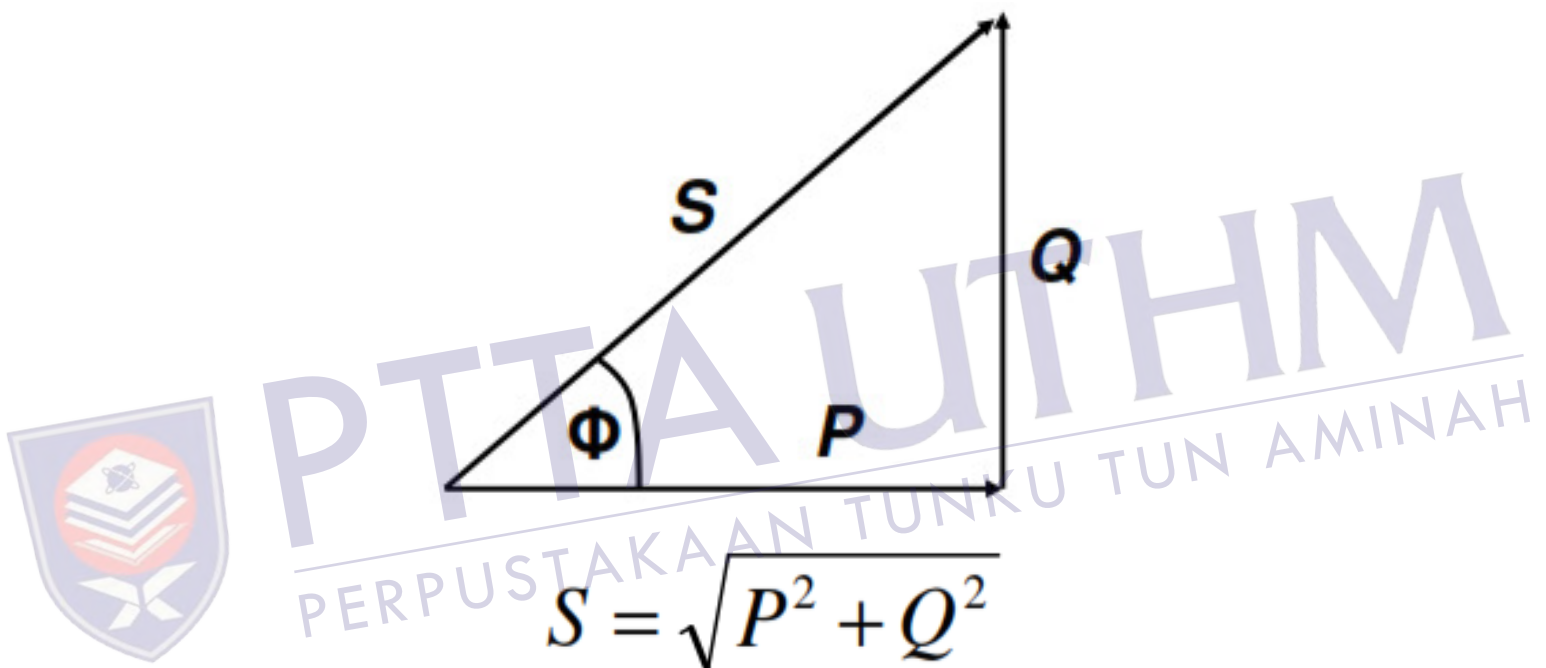

Figure 5: Ratio between P(Real), Q(Reactive) and S(Apparent).

Traditionally, the power factor is associated with the cosine of angle between the real and apparent power components. For simplicity the apparent power can be represented as the vector sum of the real and reactive power, but in the case of non sinusoidal periodical signals a more complex relationship between these components is considered.

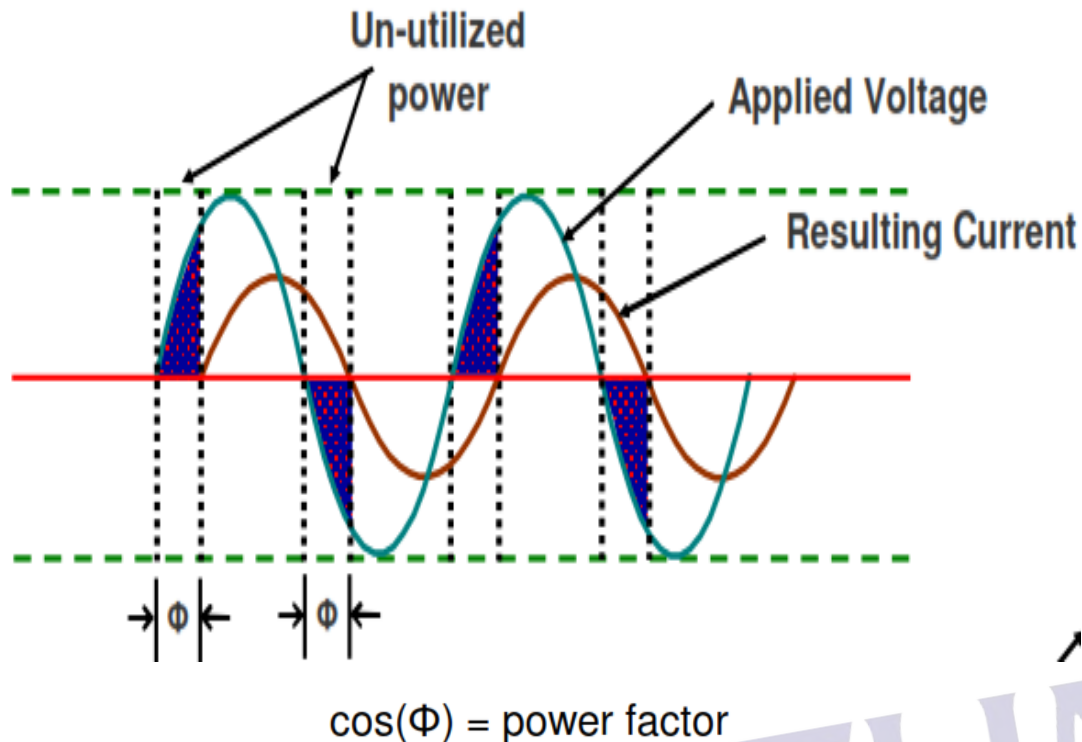

Figure 6: Voltage, Current and Power Factor

### 3.1.1.2 Theory of Rectifier

Nearly all single-phase AC-to-DC power supplies have a full-wave bridge rectifier circuit on the input, followed by a large bulk capacitor, which attempts to hold its DC voltage constant between the half-cycle peaks of the input voltage sine wave. Of course, no matter how large it is, the capacitor droops slightly between half-cycles, so when the next peak comes, the rectifier bridge conducts and recharges the capacitor.

The capacitor charging current only flows when the input voltage (less the voltage drops across the rectifiers) is greater than the voltage on the capacitor; when it is less, the rectifiers are off and little or no current flows. Therefore, the current is highly non-sinusoidal, as shown in Figure 7. The low power factor caused by the high harmonic content of the currents causes similar problems for the power company to those caused by sinusoidal reactive power, only worse. The harmonics cause distortion in the voltage waveform, and can even cause destructive resonances in the power grid.

Uncorrected power factors may be as low as 0,5 or 0,6 for this type of rectifier design. A similar situation applies to three-phase mains power, but the rectifier bridge has six diodes instead of four, and the phase peaks six times per cycle instead of twice.

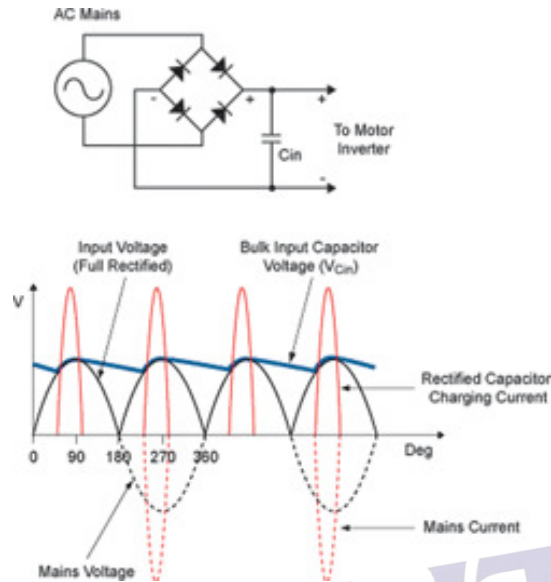

Figure 7: Simple rectifier without power factor correction (PFC) draws current from the AC mains with a high harmonic content, and hence a low power factor

### 3.2 PID Control Design

The PID control scheme is named after its three correcting terms, whose sum constitutes the manipulated variable (MV). The proportional, integral, and derivative terms are summed to calculate the output of the PID controller. Defining  $u(t)$  as the controller output, the final form of the PID algorithm is:

$$u(t) = MV(t) = K_p e(t) + K_i \int_0^t e(\tau) d\tau + K_d \frac{d}{dt} e(t)$$

where

$K_p$ : Proportional gain, a tuning parameter

$K_i$ : Integral gain, a tuning parameter

$K_D$ : Derivative gain, a tuning parameter

$e$ : Error

$t$ : Time or instantaneous time (the present)

$T$ : Variable of integration; takes on values from time 0 to the present

### 3.2.1 Derivative Term

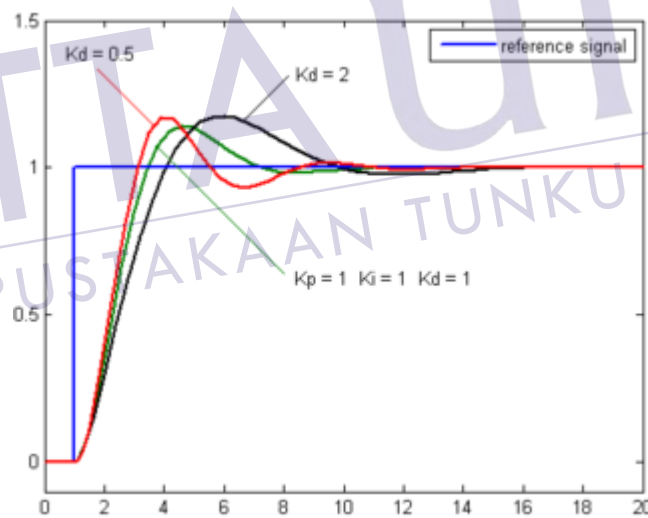

Figure 8: Plot of PV vs time, for three values of  $K_d$  ( $K_p$  and  $K_i$  held constant)

The derivative of the process error is calculated by determining the slope of the error over time and multiplying this rate of change by the derivative gain  $K_D$ . The magnitude of the contribution of the derivative term to the overall control action is termed the derivative gain  $K_D$ .

The derivative term is given by:

$$D_{\text{out}} = K_d \frac{d}{dt} e(t)$$

The derivative term slows the rate of change of the controller output. Derivative control is used to reduce the magnitude of the overshoot produced by the integral component and improve the combined controller-process stability. However, the derivative term slows the transient response of the controller. Also, differentiation of a signal amplifies noise and thus this term in the controller is highly sensitive to noise in the error term, and can cause a process to become unstable if the noise and the derivative gain are sufficiently large. Hence an approximation to a differentiator with a limited bandwidth is more commonly used. Such a circuit is known as a phase-lead compensator.

### 3.2.2 Integral Term

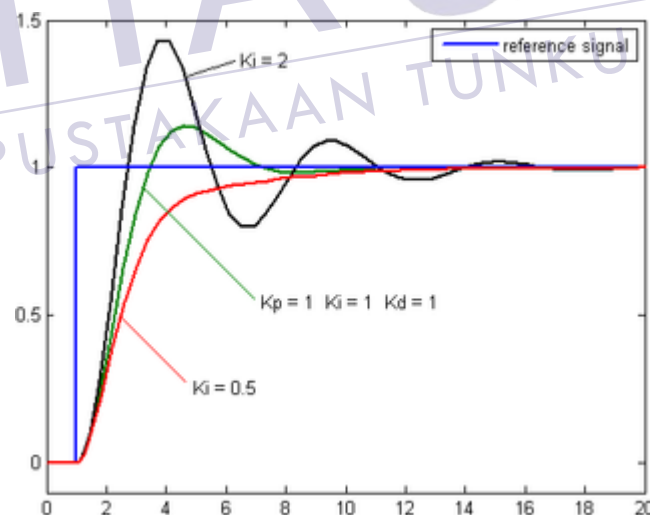

Figure 9: Plot of PV vs time, for three values of  $K_i$  ( $K_p$  and  $K_d$  held constant)

The contribution from the integral term is proportional to both the magnitude of the error and the duration of the error. The integral in a PID controller is the sum of the instantaneous error over time and gives the accumulated offset that should have

been corrected previously. The accumulated error is then multiplied by the integral gain ( $K_I$ ) and added to the controller output.

The integral term is given by:

$$I_{\text{out}} = K_i \int_0^t e(\tau) d\tau$$

The integral term accelerates the movement of the process towards setpoint and eliminates the residual steady-state error that occurs with a pure proportional controller. However, since the integral term responds to accumulated errors from the past, it can cause the present value to overshoot the setpoint value (see the section on loop tuning).

### 3.2.3 Proportional Term

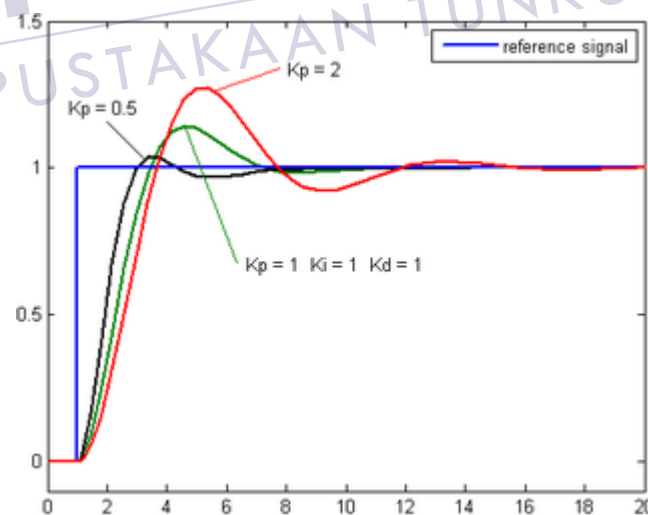

Figure 10: Plot of PV vs time, for three values of  $K_p$  ( $K_i$  and  $K_d$  held constant)

The proportional term produces an output value that is proportional to the current error value. The proportional response can be adjusted by multiplying the error by a constant  $K_p$ , called the proportional gain constant.

The proportional term is given by:

$$P_{\text{out}} = K_p e(t)$$

A high proportional gain results in a large change in the output for a given change in the error. If the proportional gain is too high, the system can become unstable (see the section on loop tuning). In contrast, a small gain results in a small output response to a large input error, and a less responsive or less sensitive controller. If the proportional gain is too low, the control action may be too small when responding to system disturbances. Tuning theory and industrial practice indicate that the proportional term should contribute the bulk of the output change.

### 3.3 Saw-Tooth Signal Generator

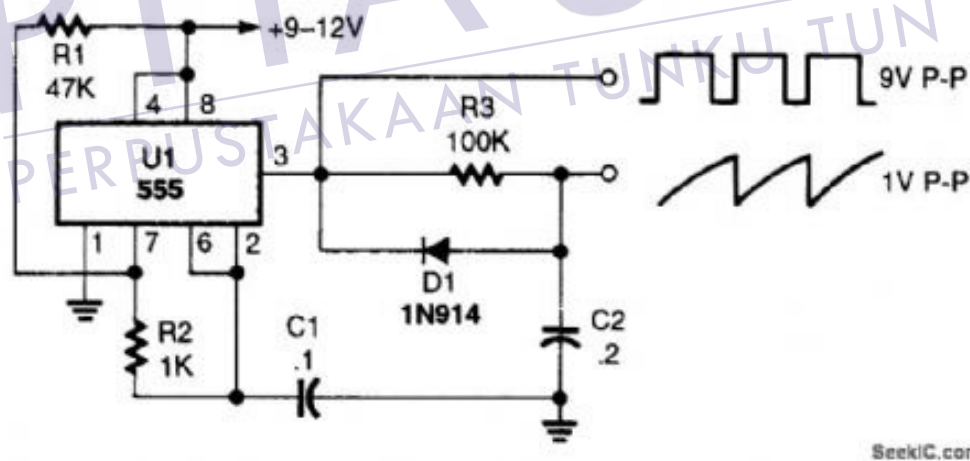

Figure 11: Saw-tooth waveform generator

A saw-tooth waveform generator circuit using a 555 IC is shown. The IC is connected in an astable oscillator circuit with the majority of the output contained in the positive portion of the cycle. The negative output is a very brief pulse. Capacitor C2 charges through R3 in a positive direction during the time that the IC's output (at pin 3) is high. When the output goes negative, C2 is rapidly discharged through D1 and the IC's output. Peak-to-peak saw-tooth output is about 1 V. The linearity of this



circuit is best when R3 is as large as possible. The oscillator's frequency is about 0.5 MHz and can be increased by lowering either the value of R1 or C1 to decrease the frequency, increase the values of those components.

### 3.4 Buck Converter Formula

For a buck converter, it is obvious that

$$\Delta i_L = \frac{1}{L}(V_g - V_o) \times DT$$

The peak-peak output voltage ripple  $\Delta v_o$ . From the information of the capacitor current  $i_c$ , we can obtain  $\Delta v_o$

$$\Delta v_o = \frac{\Delta i_L}{8fC}$$

If the desired switching frequency and the value of the inductor  $L$  are established, the minimum load resistance required for CCM is

$$R_{\min} = \frac{2fL}{(1-D)}$$



## CHAPTER 4

### SIMULATION MODEL

#### 4.1 Simulation Close Loop Result

In this chapter simulation of AC-DC before and after PFC in figure 12 & 13:

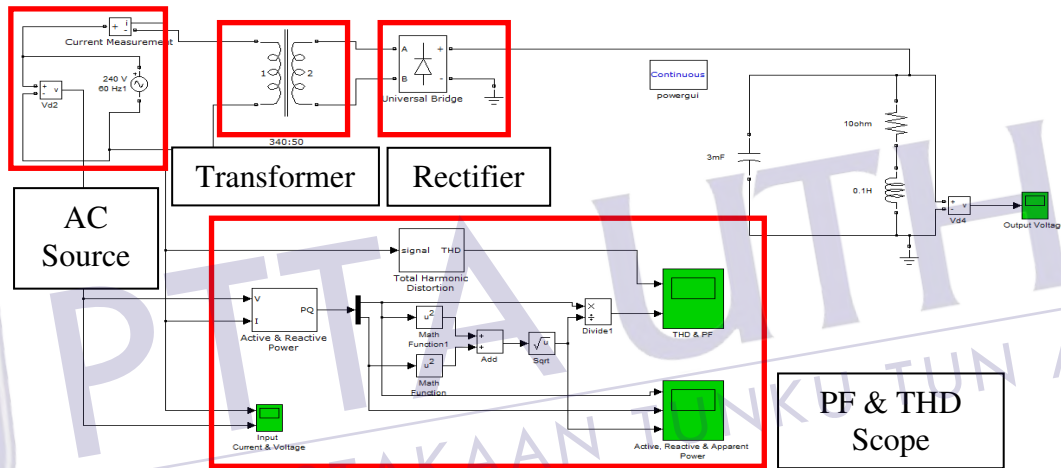

Figure 12: AC-DC by using Step-down transformer and rectifier

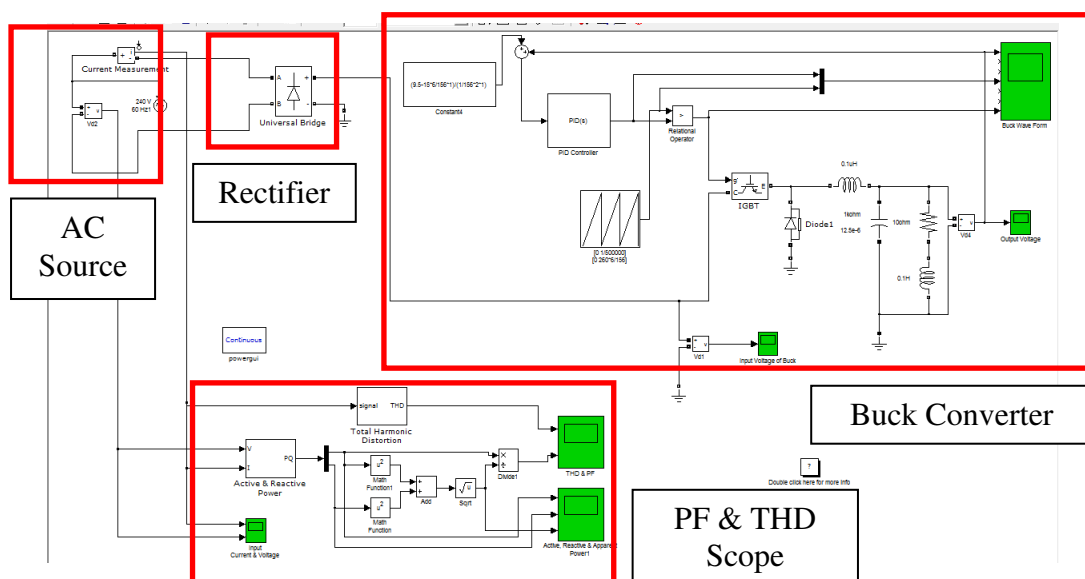

Figure 13: AC-DC by using rectifier and Buck PFC circuit

The current flow through step down transformer and rectifier is highly non-sinusoidal. Capacitor current flows when the input voltage less then voltage across the rectifiers is greater than the voltage on the capacitor; when it is less, the rectifiers are off and little or no current flows. And after apply Buck PFC the line current follow the wave form of the line voltage. It makes the system behave like a purely resistor.

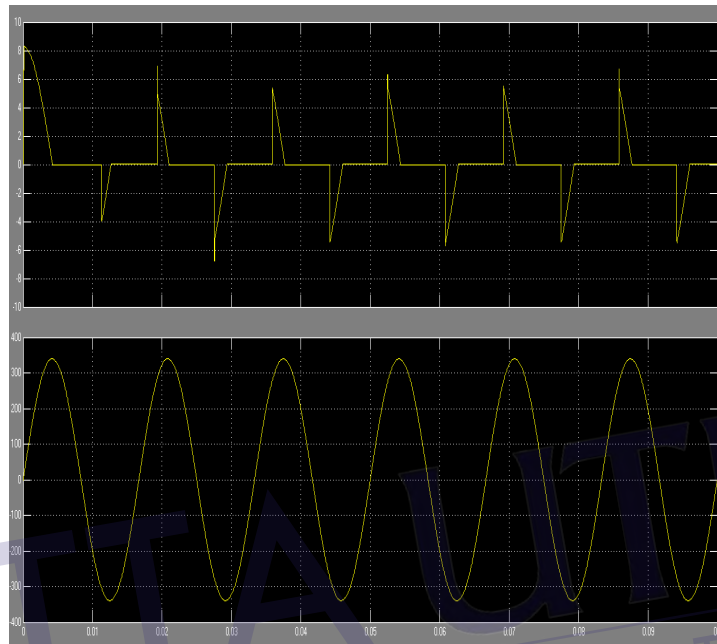

Figure 14: Rectifier input current and voltage of AC-DC by using Step-down transformer and rectifier

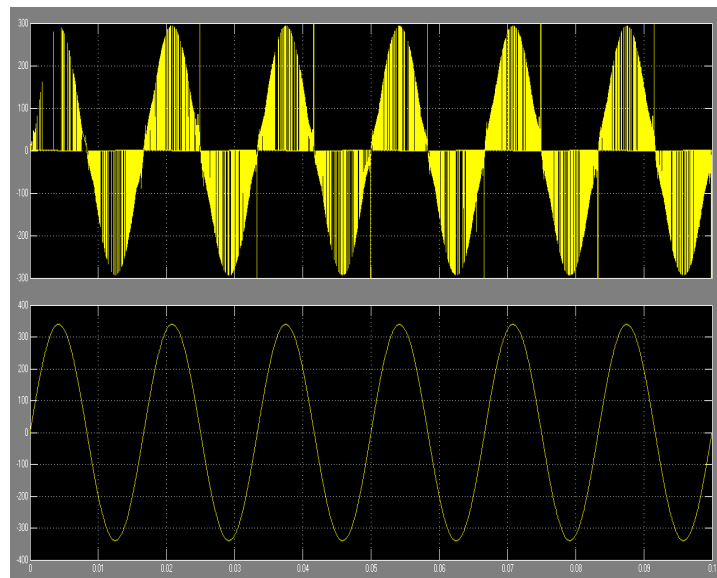

Figure 15: Buck input current and voltage of AC-DC by using rectifier and Buck PFC circuit

For reactive power (Var), AC-DC by using Step-down transformer and rectifier require higher reactive power (Var) then AC-DC with PFC. As the result, total apparent (VA) for AC-DC without PFC much higher.

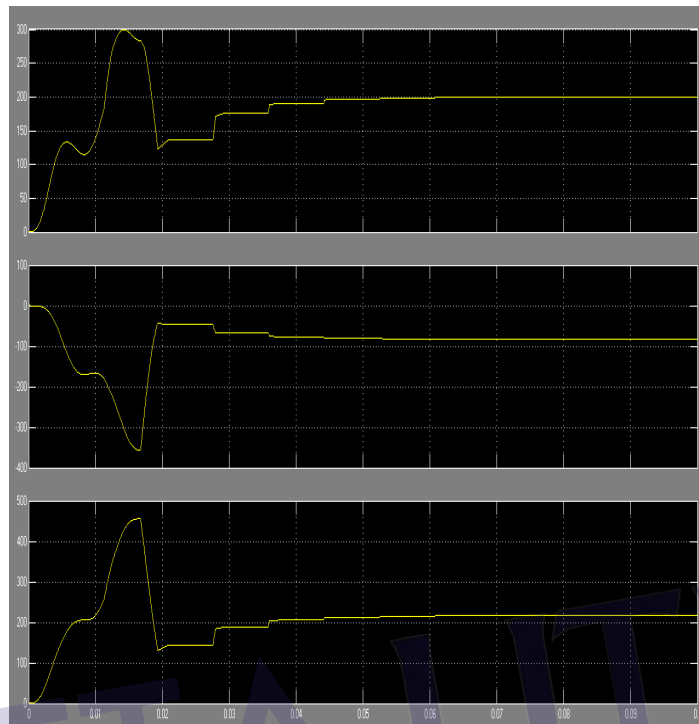

Figure 16: Rectifier, Active and Reactive Power of AC-DC by using Step-down transformer and rectifier

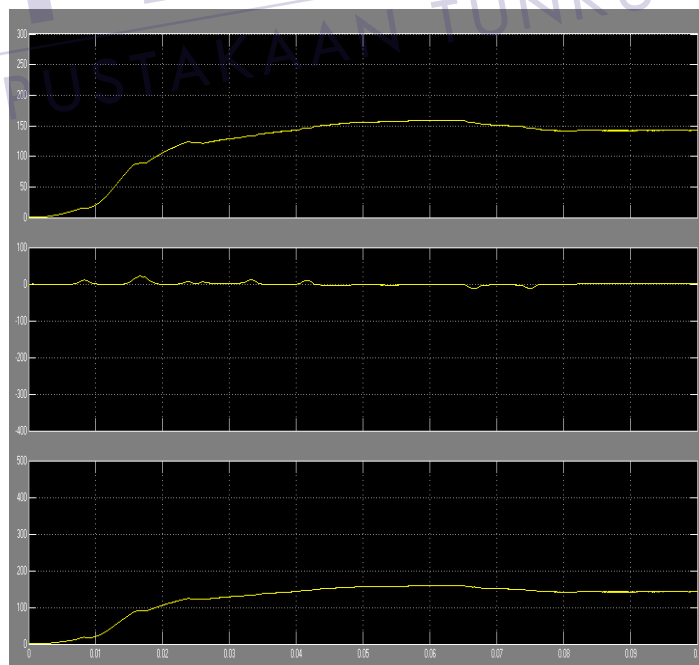

Figure 17: Buck Active and Reactive Power of AC-DC by using rectifier and Buck PFC circuit

And for THD and power factor is higher for Buck PFC and lower for AC-DC by using Step-down transformer and rectifier. Unity (Higher) power factor much better but higher THD will reduce the power factor and increase apparent power (Var).

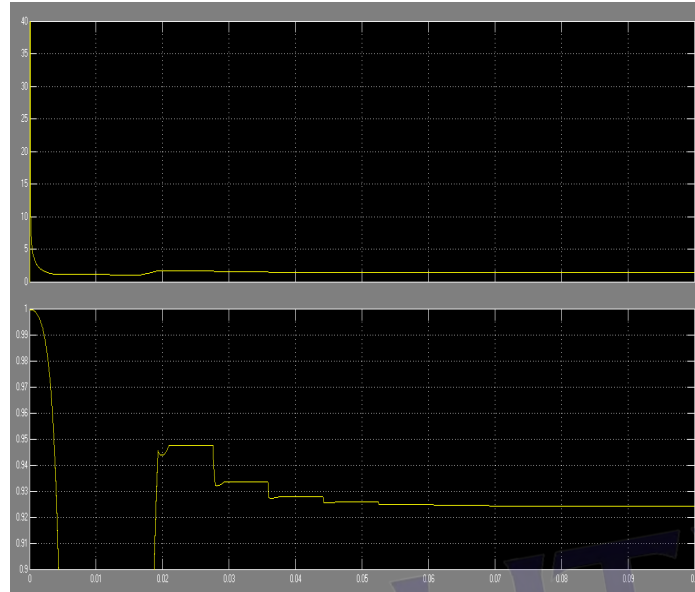

Figure 18: Rectifier THD and power factor of AC-DC by using Step-down transformer and rectifier

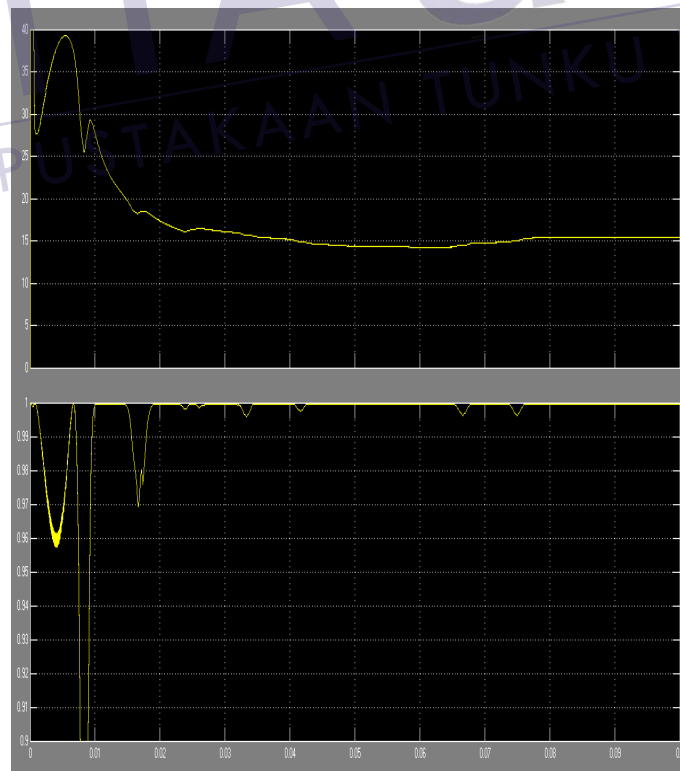

Figure19: Buck THD and power factor of AC-DC by using rectifier and Buck PFC circuit

Output voltage of AC-DC by using Step-down transformer and rectifier much constant compare with Buck PFC. Buck converter execute once the input voltage higher then output voltage requires. Due to input voltage of Buck Converter from full-bridge rectifier, output voltage of Buck Converter un-constant.

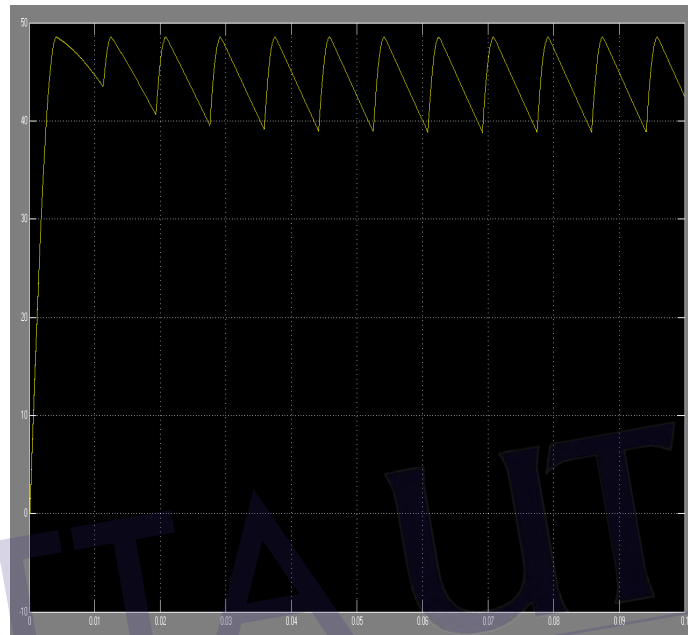

Figure 20: Rectifier Output Voltage of AC-DC by using Step-down transformer and rectifier

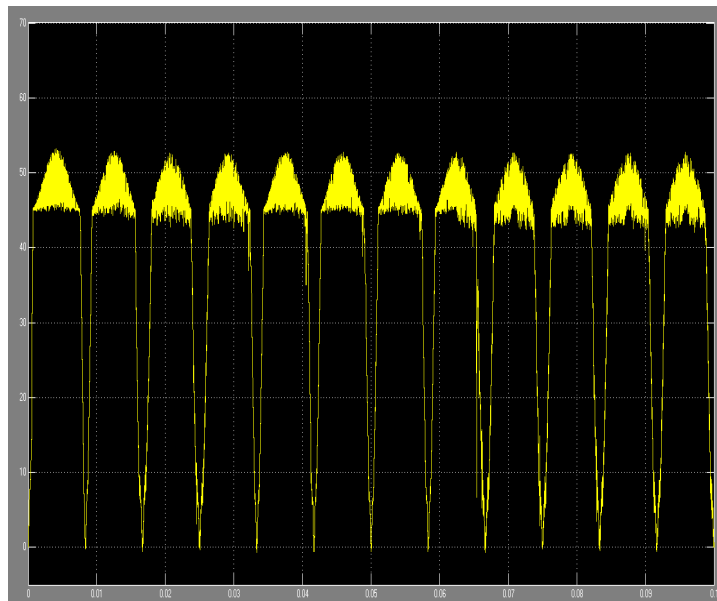

Figure 21: Buck Output Voltage of AC-DC by using rectifier and Buck PFC circuit

### 4.1.1 Changes of Output Load

Output voltage using buck converter during output load under open condition, by simulation such as 10kohm, the output voltage seem constant. The output voltage nearly same as AC-DC by using step-down transformer and rectifier. During output load decrease, output voltage characteristic same as previous chapter.

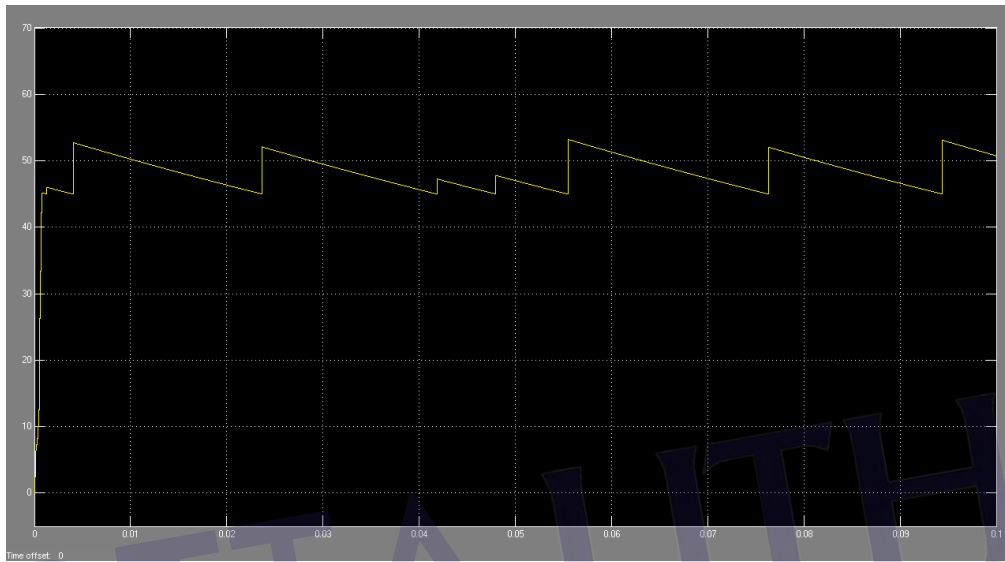

Figure 22: Output load 10,000ohm for Output Voltage of AC-DC by using rectifier and Buck PFC circuit

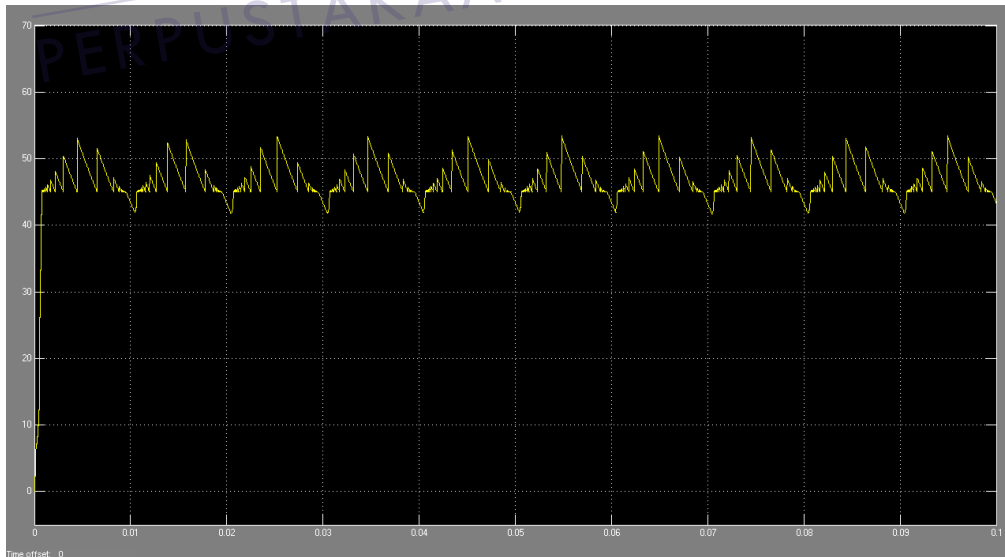

Figure 23: Output load 1,000ohm for Output Voltage of AC-DC by using rectifier and Buck PFC circuit

When the output load is 1000ohm, the output voltage constant. The output voltage pick-to-pick about 5V. But, when the output load 100ohm, voltage minimum drop to 22V. At 10ohm output load, minimum voltage drop to 3V. Output load drop, voltage minimum drop.

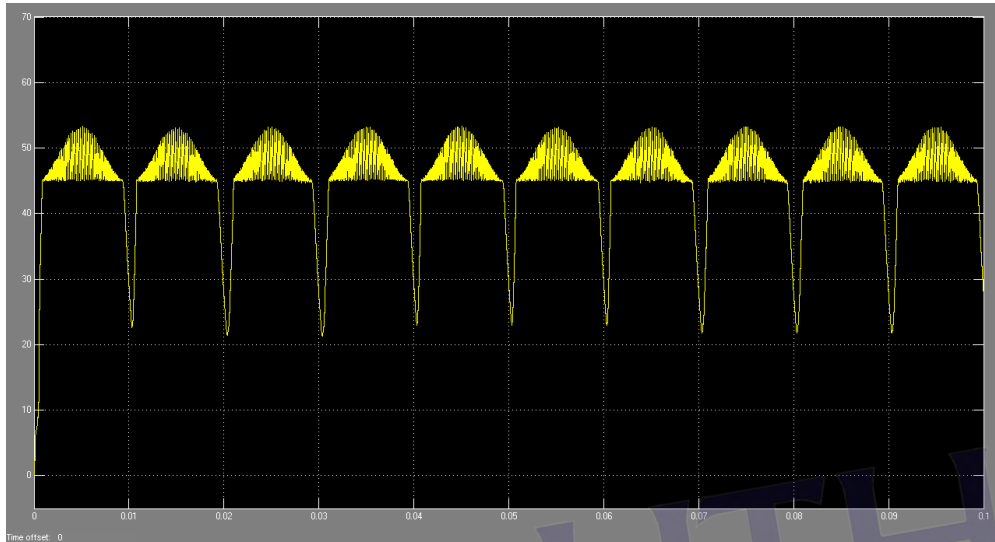

Figure 24: Output load 100ohm for Output Voltage of AC-DC by using rectifier and Buck PFC circuit

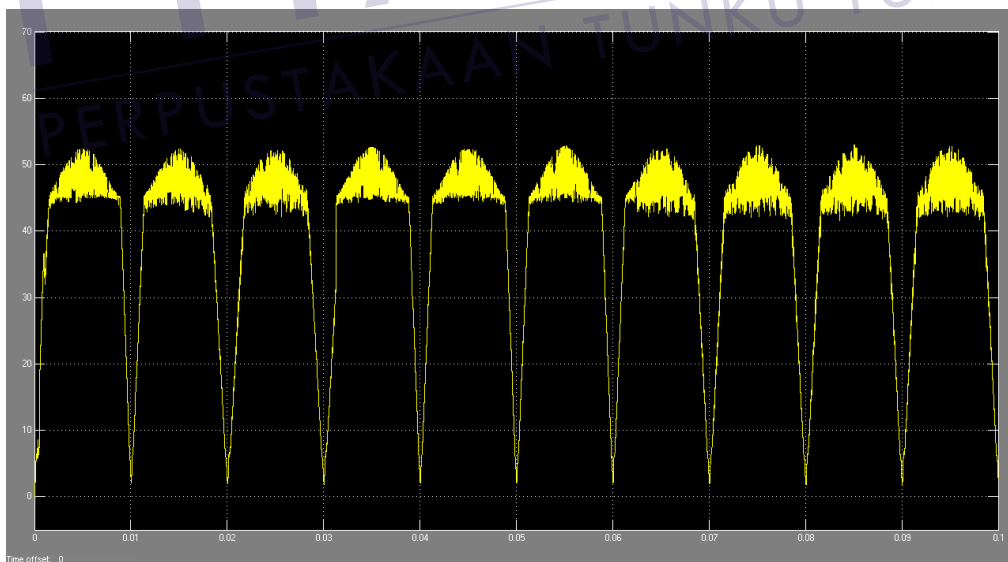

Figure 25: Output load 10ohm for Output Voltage of AC-DC by using rectifier and Buck PFC circuit

Power factor during the output load is open condition, by simulation the output load such as 10,000ohm. The power factor is unstable. But the power factor



## REFERENCES

[1] Philip C. Todd, "UC3854 Controlled Power Factor Correction Circuit Design", UNITRODE product and application handbook, 1995-1996.

[2] Laszlo Huber, Member IEEE, Liu Gang, and Milan M. Jovanovic, Fellow, IEEE, "Design Oriented Analysis and Performance Evaluation of Buck PFC Front End", 0885-8993/\$26.00, 2010, IEEE.

[3] Huai Wei, IEEE Member, and Issa Batarseh, IEEE Senior Member, University of Central Florida, Orlando, FL 32816, "Comparison of Basic Converter Topologies for Power Factor Correction", 0-7803-4391-3/98/\$10.00 1998 IEEE.

[4] Smruti Ranjan Samal and Sanjay Kumar Dalai, "Power Factor Correction in a Single Phase AC-DC Converter", N.I.T. Rourkela, 2010.

[5] L. Rossetto, Department of Electrical Engineering, G. Spiazzi & P. Tenti, Department of Electronics and Informatics, University of Padova, Via Gradenigo 6/a, 35131 Padova – Italy, 1994.

[6] Everett Rogers, "Understanding Buck-Boost Power Stages in Switch Mode Power Supplies" Texas Instrument Application Report, 2002

[7] Barry W Williams, "Principles and Elements of Power Electronics" Glasgow: Barry W Williams, 2005

[8] Bernard Keogh, "Power Factor Correction Using the Buck Topology – Efficiency Benefits and Practical Design Considerations" Texas Instrument Power Supply Design Seminar, 2010

[9] W Mack Grady, "Harmonics And How They Related To Power Factor" The University of Texas at Austin, 1993

[10] Yiqing Zhao, “ Single Phase Power Factor Correction Circuit With Wide Output Voltage Range” Virginia Polytechnic Institute and State University, 1998

[11] R Ridley, S. Kern, B. Fuld, “Analysis and design of a wide input range power factor correction circuit for three phase application”, IEEE Applied Power Electronics Conference, 1993



PTTA UTHM  
PERPUSTAKAAN TUNKU TUN AMINAH